

## • Frequent problems for mothers

### 1. Slow pumping

- Pumping speed is different from person to person, more milk, large suction does not mean that it sucks fast, it is affected by breast structure, breast patency, mood, etc., it is normal to give milk less quickly than others. In addition, pumping regularly will also make pumping smoother.
- Solution for slow pumping: Before pumping, use a hot towel to compress the breast, and then massage for 2 minutes in lactating mode, and the program will automatically switch to pumping mode. Set to high suction in pumping mode, you can also massage with your hands to stimulate the breast.

### 2. Fail to pump milk or breast pain

- Breast is swollen and painful, but milk does not come out, it may be caused by mammary gland obstruction; mammary gland obstruction may cause mastitis, please go to the hospital in time. Pumping pain can also be caused by mild mastitis. Timely emptying of the breast is conducive to preventing mastitis.
- Solution for breasts blockage and pain in pumping.

A. You can go to the drugstore to buy some dandelions and boil them with water, wrap the warm dandelions with gauze, apply it to the place of the lump, warm it if it is cooled, apply it for 2-3 hours continuously, apply about 5 times a day, and the pain will be reduced or even disappeared the next day;

B. Massage breasts:



#### **Circular massage**

Place your hands above and below the breasts and massage the entire breasts in a circular direction



#### **Spiral massage**

Hold the breast with one hand, index finger and thumb of the other hand rub the nipple in a spiral shape

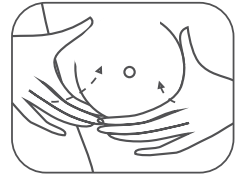

#### **Shiatsu massage**

Place your hands open on either side of your breasts and squeeze from the breasts to the nipples

C. Keep a happy mood and get enough sleep. (That keeping a happy mood can promote milk secretion is not just an empty talk, scientific research has confirmed that depression will cause the adrenal glands in the body to release the stress hormone epinephrine, causing the blood vessels around the breast to tighten, thereby reducing the effect of oxytocin on the lactation reflex of the breast glands, then milk flow is delayed and milk cannot be expressed.)

### 3. Pumping pain

- The degree of force on the human body is not always the same, it is like going to a massage parlor for a massage, some people are very resistant to force, while some people cry out in pain under a small force of touch. If you feel pain during suction, on the one hand, straighten the flared hood to make sure the nipple is aligned with the hole; in addition, lower the suction level, as the number of pumping increases, the human body will adapt to this suction and will not feel pain.

### 4. There is milk after squeezing by hand

- The structure of the human breast is divided into a network of ducts, and no method of expression can completely remove all milk. This is influenced by the intensity of expression and the frequency of pumping. After each method of milk expression, a different method of expression will result in milk leakage.
- After electric suction, you can still express the milk manually; and vice versa, after manual expression, you can also express milk using an electric breast pump.

### • Proper pouring method

**Note: There is no storage bottle included in this set, you will need to purchase it separately.**

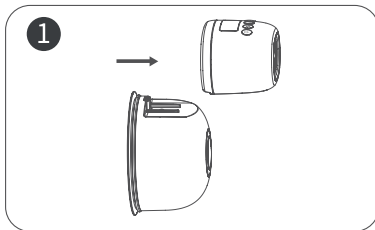

Note: There is no storage bottle included in this set, you will need to buy it separately

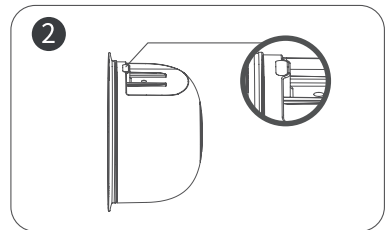

The outlet port is shown in the figure (Do not invert to avoid breast milk spill)

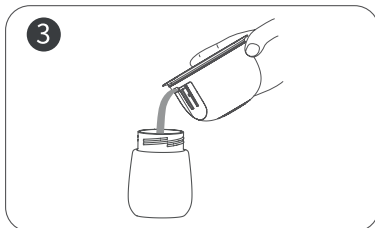

Pour the milk from the shell into the storage bottle

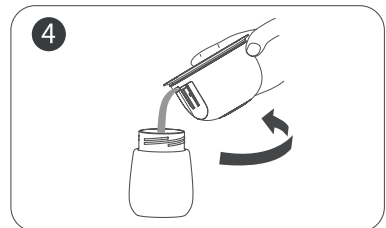

When pouring milk, you can rotate the shell to pour out the remaining milk

## • Proper pouring method

The wearable electric breast pump is especially designed for nursing mothers. It simulates the baby's pumping rhythm using microcomputer frequency converting technology, and has 9-level pumping adjustment, and 3 modes of lactating, pumping, and stimulation; The lightweight, compact size, simple design of lithium battery, modest, convenient and fast operation provide mothers with effective and comfortable milk collection experience.



### **Intelligent frequency conversion mode**

Three modes of lactating, pumping, and stimulation can effectively solve the problems faced by mothers in an early secretion and pumping.

---



### **Soft and skin-friendly breast shield**

Food grade contact material, skin-friendly design, gentle contact with breast, allow painless breast pumping for mothers.

---



### **Intelligent memory mode**

Intelligent memory program settings, can automatically remember the appropriate level before shutting down, more convenient for milk expression.

---



### **Compact and portable design**

Take it with you, integrated model without connecting tube, portable, so you can go out freely, you can take it to work, helps working mothers.

---



### **Large capacity lithium battery**

1400mAh built-in large capacity lithium battery supports one charge for multiple use, and meets the needs at home and when you go out.

---



### **Fewer accessories, easy to assemble**

Fewer accessories, more convenient to assemble and disassemble, you can take off the main unit, and it is more convenient to clean the accessories.

## • Product specifications

Name	InnoGIO GIOluna Smart	Model	GIO-353
Input voltage	DC 5V 1A	Rated power	5W
Lithium battery	1400mAh 5.18Wh	Battery voltage	DC3.7V
Package	2 pcs	Place of origin	China
Recommended room temperature	5°C~40°C	Year of manufacture	Marked on the box
Use environment	Indoors		
*Note: Please use the 5V—1A adapter with the maximum output power of less than 15W.			

## • Product parts

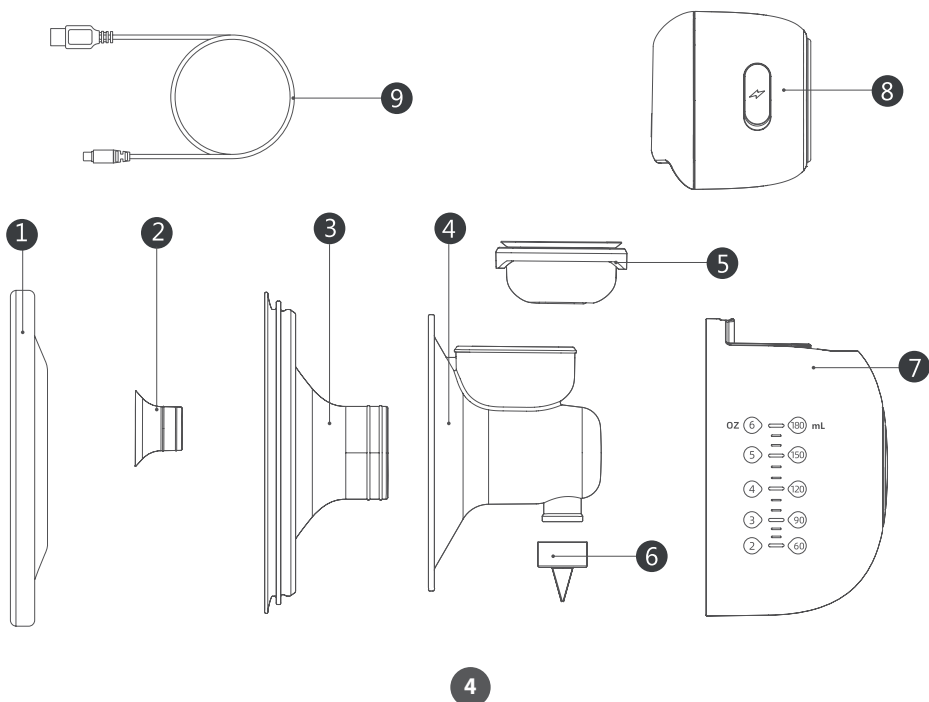

No.	Name	Material	Temperature resistance	QTY
1	Dust cover	PP	-20°C~120°C	2
2	24mm Flange insert	Silicone	-20°C~200°C	2
3	Breast shield (27 mm)	Silicone	-20°C~200°C	2
4	Connector body	PP	-20°C~120°C	2
5	Membrane	Silicone	-20°C~200°C	2
6	Duckbill valve	Silicone	-20°C~200°C	4
7	Collection shell	PP	-20°C~120°C	2
8	Main unit	-	-	2
9	USB cable	-	-	2

\*Note: 24mm flange insert, breast shield (27mm), connector body, membrane and duckbill valve are components for food contact.

## • Panel display

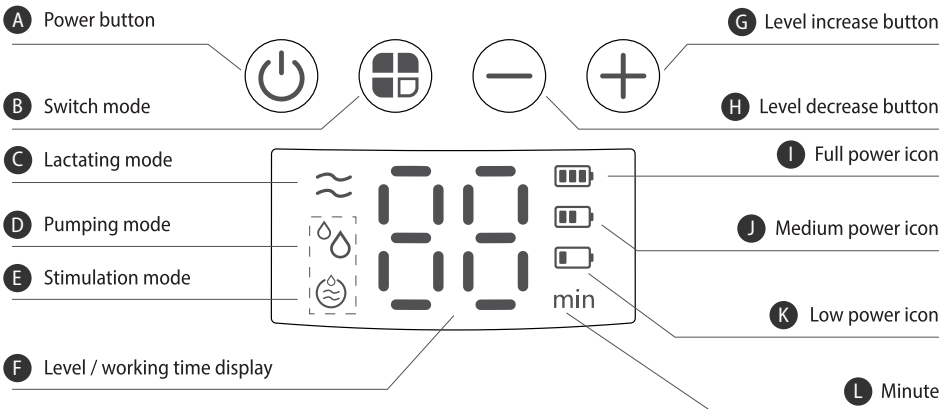

## Button descriptions

### **Power button**

Press and hold 2s to turn on/ off, press to pause, the device shuts down automatically after pausing for 5 minutes without operation; the product automatically shuts down after working for 30 minutes.

### **Switch mode**

Press to cycle through lactating mode, pumping mode and stimulation mode.

### **Increase level**

Suction increase button. (A total of 9 levels, level 9 is the most powerful)

### **Decrease level**

Suction decrease button. (A total of 9 levels, level 1 is the weakest)

## Icon descriptions



### **Lactating mode**

A total of 9 levels with fast pumping frequency and small suction to effectively stimulate the mammary gland for lactating.



### **Pumping mode**

A total of 9 levels with slow pumping frequency and large suction, suitable for rapid milk collection.



### **Stimulation mode**

A total of 9 levels, lactating and pumping modes are combined to simulate the baby's pumping, making the pumping process more immersive.







### **Level/ working time display**

Display the current working level of the device, and the current accumulated working time.



### **Battery power display**

The power is sufficient , half of the power is consumed , the power is insufficient , the device will automatically shut down soon 

## • Method of assembly

Please check whether the relevant accessories are assembled correctly before pumping.

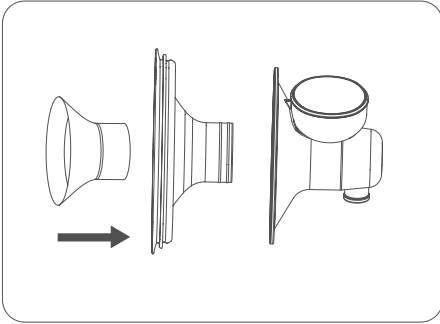

1. Insert flange insert into the breast shield and ensure a tight fit.

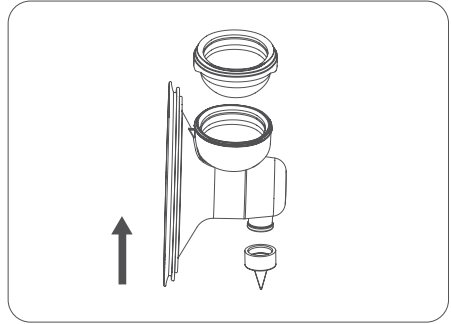

2. Attach the membrane and the duckbill valve to the connector body. (As shown in the figure).

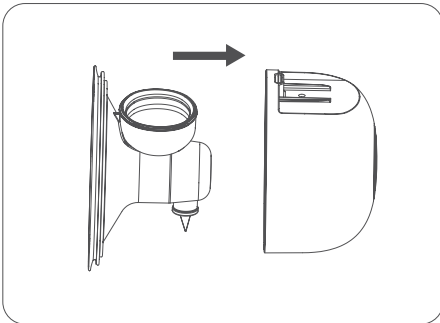

3. Attach the collection shell assembly to the connector body, ensure tight fit. (As shown in the figure).

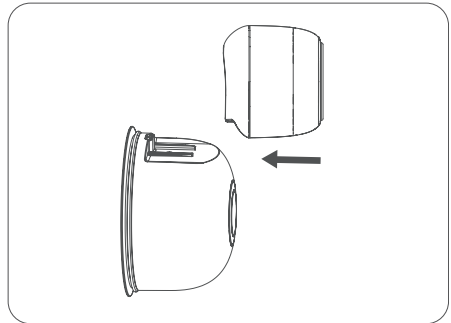

4. Fasten the main unit onto the collection shell assembly, ensure tight fit. (As shown in the figure).

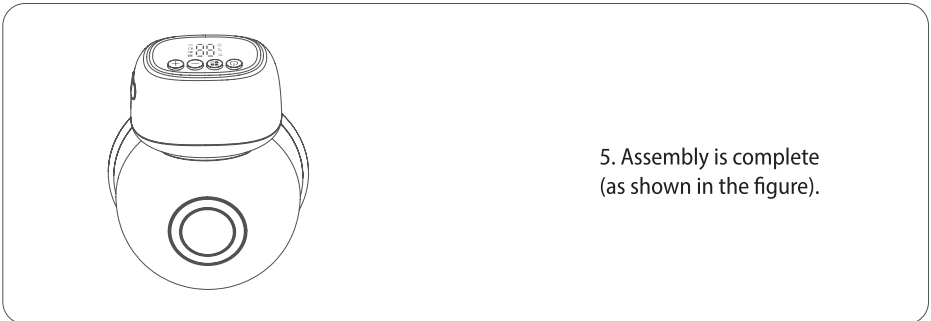

5. Assembly is complete (as shown in the figure).

## • Operating instructions

1. Wash your hands before use, confirm that the breast pump assembly is thoroughly cleaned and properly installed in place according to the assembly instructions.
2. Use warm towels to compress and massage the breast before pumping, to get better pumping effect.

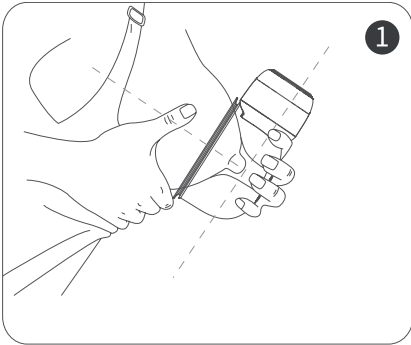

3. Align the center of the assembled breast shield with the pacifier and keep it close to the breast, and hold the breast with the other hand to ensure that no air enters. (Figure 1).

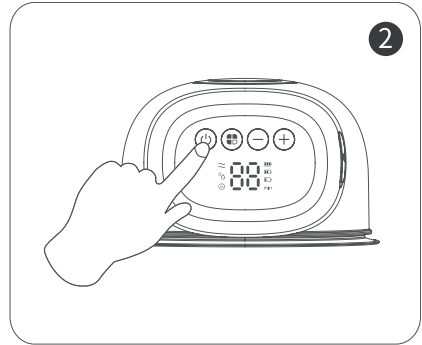

4. Press and hold the power button to start up, press it to pause pumping, press again to continue pumping. (Figure 2).

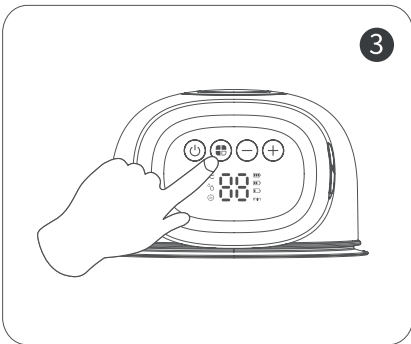

5. The product is in lactating mode by default after started up, press  during work to switch through three modes, such as lactating, pumping and stimulation. (Figure 3).

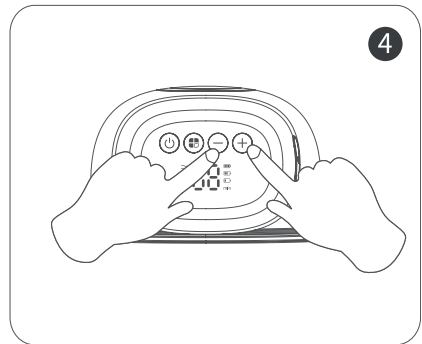



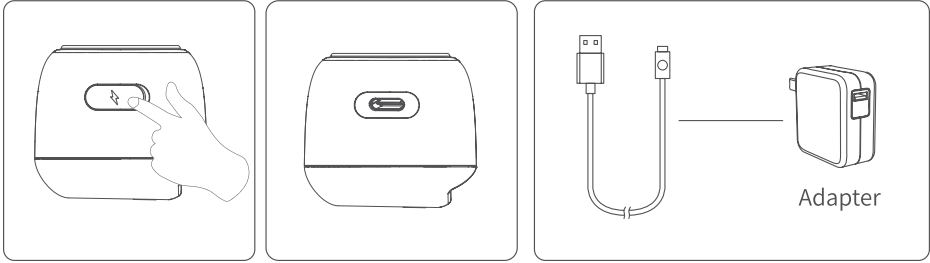

4. During the normal operation of the device, press "+" and "-" to switch levels from 1 to 9 levels. (Figure 4).

## • Power connection

Please open the silicone plug of the charging port on the side of the main unit, plug the type-C connector of the USB power cable into the charging port on the side of the device, and plug the other end of the USB connector into the DC5V/1A adapter, power bank or USB port. (As shown in the figure).



### The device automatically recognizes the battery level

- When the battery is low, the power indicator , flashes in red, please charge in time.
- When the battery is full, the display shows .
- When half of the power is consumed, the display shows .
- When the battery is low, the display shows .
- During charging, the power indicator flashes , when fully charged, it is normally on.

Note: Do not use it while charging. (You need to have your own power adapter, specification: DC5V/1A).

## • Troubleshooting

Fault	Solution
The device does not work	<ul style="list-style-type: none"> <li>• The battery is low; please fully charge it before use, check whether the DC port is properly inserted during charging;</li> </ul>
Little or no suction	<ul style="list-style-type: none"> <li>• Check whether all parts are securely connected, ensure that there are no air leaks;</li> <li>• Reassemble according to the assembly procedure;</li> <li>• Check that the air outlet of the duckbill valve opens and closes normally</li> <li>• Check whether the breast shield fits the breast perfectly.</li> </ul>
The power indicator shows "E1" code	<ul style="list-style-type: none"> <li>• When the level indicator of the adapter is larger than 6.5V, it shows "E1" code, the main unit enters over-voltage protection and cannot be charged;</li> <li>• Please use 5V adapter to charge, and the device will resume normal charging.</li> </ul>

## • Cleaning precautions

- Please read the manual carefully before using this product;
- Please clean the parts in contact with breast milk immediately after use to avoid milk residue and the breeding of bacteria;
- Before cleaning, please remove all accessories that come into contact with the breast or breast milk (except the main unit);
- When disassembling or assembling, please assemble each part in order; when disassembling and cleaning, please be careful with small parts, avoid loss that may make it impossible to assemble or the device not to operate.
- After cleaning, put the collection shell, breast shield assembly into the sterilization pot for sterilization (except the main unit and USB cable).
- Do not put the breast pump main unit in water for cleaning and disinfection; do not put it into the steam sterilizer for sterilization;
- Do not place the product or disassembled parts in places accessible to infants and young children to avoid danger;
- If you want to use the breast pump during the low milk production stage, please use it according to the guidance of your doctor or nursing personnel;
- If the main unit is damaged, do not remove it by yourself. It shall be repaired or replaced by the manufacturer or professionals. The product and all parts of the package must be kept out of the reach of children.

## • Warning

1. This product can be used by persons with reduced physical, sensory or mental capabilities or lack of experience and knowledge if they have been given supervision or instruction concerning use of the appliance in a safe way and understand the hazards involved. Children shall not play with the appliance. Cleaning and user maintenance shall not be made by children without supervision.
2. This product must only be supplied at safety extra low voltage corresponding to the marking on the appliance.
3. This product contains batteries that are non-replaceable.
4. To avoid infection and disease, this product is only for single user.

## • Lithium battery use precautions

- It is forbidden to disassemble, impact, crush or throw into fire.
- Do not leave in high temperature environments.
- If severe swelling occurs, do not continue to use.
- Do not attempt to replace the battery yourself, which may damage the battery, and cause overheating, fire, and personal injury.
- Do not disassemble the battery, some components in lithium batteries are flammable, harmful and can cause injury, fire, cracking or explosion.
- It is forbidden to disassemble, open, cut up, or scrape through the battery or battery pack with metal.
- Only use a standard adapter that meets the standard for charging, otherwise it will be dangerous. Do not charge the battery pack for a long time
- Lithium batteries can only be replaced by the company or authorized service providers, and replacing them with the wrong model battery will have the risk of explosion; the device must be powered off before removing the battery.
- Dispose of discarded batteries or battery packs in accordance with national environmental protection regulations.

## • Disposal of your pump

At the end of its operating life, separate all the parts of your breast pump.

Dust cover, Flange insert, Connector body, Suction bowl, Valve and Milk collector are made of plastic or silicone. You may follow separate collection according to local collection and recycling systems.

Pump motor, including USB charging cable (electronic equipment) may contain hazardous substances and are not allowed to dispose of together with unsorted municipal waste.

The integrated battery must not be removed for disposal. If the battery should leak, the breast pump must be disposed of.

Electronical and electronic products (EEE) are indicated with the following symbol:



















In the European Union, United Kingdom and Switzerland the manufacturer or its vendor must take back EEE waste equipment, other countries may have similar collection and recycling systems. This product contains batteries that are non-replaceable and must not be removed for disposal.

#### NOTICE

Dispose of waste equipment according to local regulations. Inquire at the point of sale or contact your local authority for appropriate collection points for waste equipment. The separate collection and recycling of your waste appliance at the time of disposal will help conserve natural resources and ensure that it is recycled in a manner that protects human health and the environment.

# innogio

Manufactured in China for INNOGIO Sp. z o.o.  
Ostródzka Street 74H, 03-289 Warsaw, Poland  
[www.innogio.pl](http://www.innogio.pl)

-  Scan the QR code to download the manual
-  Zeskanuj kod QR, aby pobrać instrukcję
-  Scannen Sie den QR-Code, um das Handbuch herunterzuladen
-  Scannez le code QR pour télécharger le manuel
-  Escanee el código QR para descargar el manual
-  Digitalize o código QR para descarregar o manual
-  Scansiona il codice QR per scaricare il manuale
-  Scan de QR-code om de handleiding te downloaden
-  Скануйте QR-код, щоб завантажити інструкцію
-  Naskenujte QR kód a stáhněte si návod k použití
-  Naskenujte QR kód a stiahnite si príručku
-  Scanează codul QR pentru a descărca manualul
-  Nuskaitykite QR kodą, kad atsisiųstumėte instrukciją
-  Nolasiet QR kodu, lai lejupielādētu rokasgrāmatu
-  Lae juhend alla, skannides QR-koodi
-  A kézikönyv letöltéséhez olvassa be a QR-kódot.
-  لي ل د ل د ل ل ي ز ن ت ل ع ي ر س ل ل ة ب ا ج ت س ا ل ا ز م ر ح س م ا

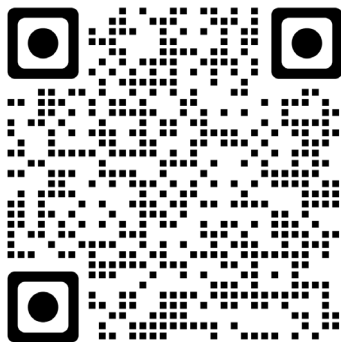

# GIÖluna Smart

Double wearable electric breast pump

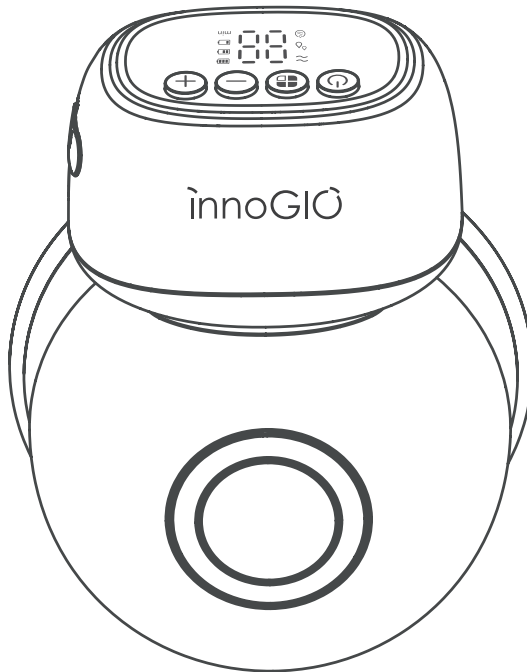

## USER MANUAL

Please read this user manual carefully before use; store in a safe place after use, thanks!