



EN ■ Hair iron

Translation of the original manual

READ CAREFULLY AND STORE FOR FUTURE USE.

General warnings

- This appliance may be used by children 8 years of age and older and by persons with physical or mental impairments or by inexperienced persons, if they are properly supervised or have been informed about how to use the product in a safe manner and understand the potential dangers.
- Children must not play with the appliance.
- Cleaning and maintenance performed by the user must not be performed by unsupervised children.
- In the event that the power cord is damaged, have it repaired at a professional service centre to prevent causing a dangerous situation. It is forbidden to use the appliance if it has a damaged power cord.



Warning:

Do not use this appliance in the vicinity of water.



Warning:

Do not use this appliance near baths, showers, washbasins or other containers containing water.

- When using the appliance in the bathroom, unplug it from the socket after use by removing the plug from the socket, as the vicinity of water poses a danger, even when the appliance is turned off.
- To ensure additional safety, it is recommended to install an Residual Current Device (RCD) into the electric circuit to the bathroom with a maximum current rating of 30 mA. Ask an electrician for advice.

Electrical safety

- Before connecting this appliance to a power socket, make sure that the voltage stated on its rating label corresponds to the voltage in your power socket.
- Connect the appliance only to a properly grounded socket. Do not use an extension cord.
- Do not disconnect the appliance from the power socket by pulling on the power cord. This could damage the power cord or the power socket. Disconnect the power cord from the power socket by pulling on the plug.
- Do not place the power cord of the appliance over sharp objects. Make sure that the power cord does not hang over the edge of a table and that it is not touching a heated or hot surface. Do not place the power cord in the vicinity of hot surfaces.
- Do not wind the power cord around the appliance. Regularly check the power cord for signs of damage.
- Keep the power cord dry.
- Never use the appliance if you have wet hands or feet. Do not connect and disconnect the power cord to and from the power socket with wet hands.
- Do not uncover the electrical parts of the appliance. They do not contain any components repairable by the user. Have the appliance serviced by qualified persons.
- To avoid potential injury by electrical shock, do not spray the appliance or its power cord with water and do not submerge it in water or any other liquid.
- Do not use the appliance if it is not working correctly, if it has been damaged or has been submerged in water.
- Always turn off the appliance and disconnect it from the power socket when you have finished using it.
- To avoid the danger of injury by electrical shock, do not repair the appliance yourself or make any adjustments to it. Have all repairs or adjustments performed at an authorised service centre. Tampering with the appliance during the warranty period may void the warranty.

Safety during use

- This appliance is designed for use in households, offices and similar types of areas. Do not use it in industrial surroundings or outdoors or in rooms with high humidity, i.e. laundries or bathrooms.
- Do not use the appliance for any other purposes than those for which it was designed.
- Only use the appliance with the original accessories from the manufacturer. Never use accessories, which have not been supplied with this appliance or which have not been explicitly recommended by the manufacturer.
- Do not expose the appliance to direct sunlight and do not place it near an open fire or appliances that are a source of heat, e.g. electric or gas stoves. Only store and use the appliance away from flammable or volatile substances.
- Only position the appliance on a clean, dry, horizontal and stable surface. Do not position the appliance on the edge of a kitchen countertop or table, or use it on the drainboard of a kitchen sink. Likewise, do not place it on window sills.
- Do not place any items on to the appliance and do not step or sit on it.
- Do not use the appliance in an excessively dusty environment.
- The appliance must not be used for styling wigs, hairpieces or synthetic hair.
- Protect the appliance against being dropped on the floor or table, even from low heights and against items falling on it.
- When the appliance is running, watch out for children and household pets.
- Never leave the appliance in operation without supervision.
- If the appliance is operating or has not fully cooled down, do not place it on soft underlays (e.g. carpets, bed linen, towels, etc.) and never cover it.
- When the appliance is used in the vicinity of children, pay increased attention and always place the appliance out of their reach.
- Do not place any paper or plastic items between the arms of the appliance.
- Prevent the appliance from coming into contact with skin.
- Never use the iron on synthetic hair or animal fur.
- Do not carry the appliance when it is hot.
- Always turn off the appliance and disconnect it from the power socket when not using it, when not planning on using it and when leaving it without supervision, before cleaning or moving it.
- Thoroughly clean dust, fats and hairdressing agents (e.g. gels, mousse, sprays, etc.) from the plates after each use – these lower the performance and lifetime of the plates.
- Never wash the appliance under running water or submerge it in water or another liquid. No part of this appliance is designed to be washed in a dishwasher.
- Before storing always allow the appliance to fully cool down.

A

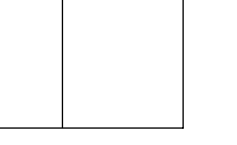
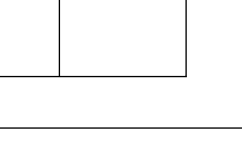
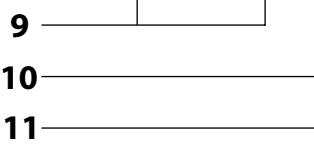
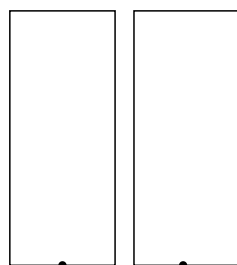
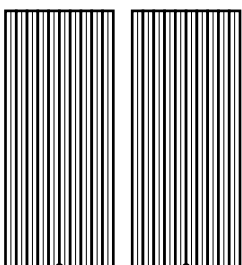
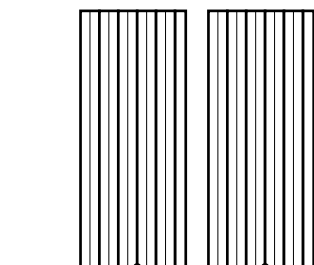
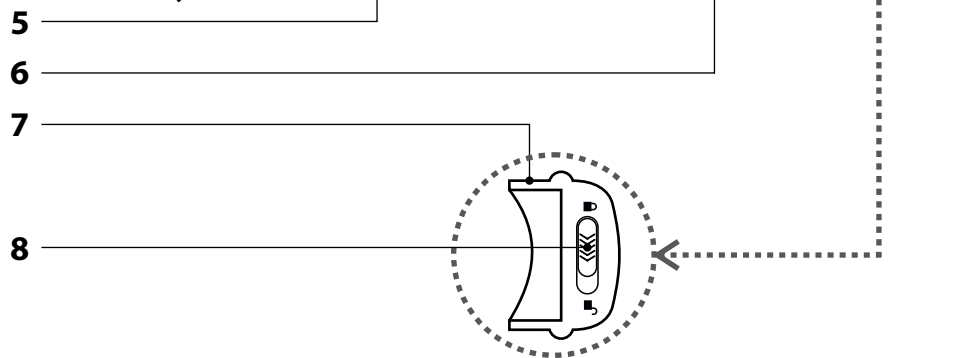
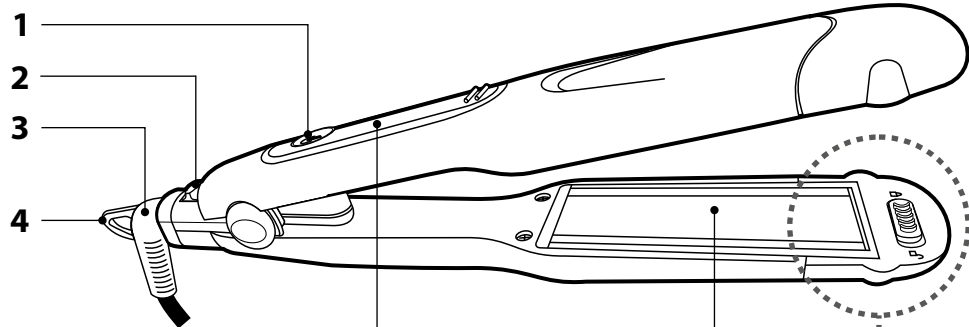

EN Hair iron

User's manual

- Prior to using this appliance, please read the user's manual thoroughly, even in cases, when one has already familiarised themselves with previous use of similar types of appliances. Only use the appliance in the manner described in this user's manual. Keep this user's manual in a safe place where it can be easily retrieved for future use. In the event that you hand this appliance over to somebody else, make sure to also include this user's manual.
- We recommend saving the original cardboard box, packaging material, purchase receipt and responsibility statement of the vendor or warranty card for at least the duration of the legal liability for unsatisfactory performance or quality. In the event of transportation, we recommend that you pack the appliance in the original box from the manufacturer.
- Carefully unpack the appliance and take care not to throw away any part of the packaging before you find all the parts of the appliance.

DESCRIPTION OF THE APPLIANCE AND ACCESSORIES

- | | |
|--|--|
| A1 Main switch | A8 Lock button (on both arms) |
| A2 Arm lock | A9 Ironing plates with large teeth
Used for creating large waves |
| A3 Swivel power cord end | A10 Ironing plates with fine teeth
Used for creating fine waves |
| A4 Hanging loop | A11 Smooth ironing plates
Used for smoothing out hair |
| A5 Display | |
| A6 Heating surface (on both arms) | |
| A7 Plate locking cover (on both arms) | |

PURPOSE OF USE AND FEATURES OF THE HAIR IRON

- The hair iron is intended exclusively for straightening, undulating and styling human hair. It must never be used for styling wigs, hairpieces, synthetic hair or for straightening animal fur.
- The iron is equipped with a temperature lock feature that prevents accidental changes to the temperature while hair is being styled, and furthermore with an automatic shut-off function that is activated after 60 minutes of inactivity.
- The heating surface for the individual plates enables operating temperatures from 140 °C to 200 °C.

APPLICATION

TURNING ON AND SETTING THE TEMPERATURE

- Connect the iron to a power socket.
- Press button **A1**. The appliance will beep, the default temperature of 140 °C will start flashing on the display and the iron will start heating up. When the temperature is reached, the value will remain permanently lit.
- By repeatedly pressing button **A1**, other temperatures are selected in the order 140 °C, 160 °C, 180 °C and 200 °C.

TEMPERATURE LOCK FUNCTION

- This function prevents accidental changes to the temperature while the iron is being used. Activate the function by holding down button **A1** for longer than 3 seconds. A lock symbol will appear on the display and the set temperature will be locked, i.e. button **A1** will not react when pressed.
- Deactivate the function by holding down button **A1** for longer than 3 seconds. The lock symbol will turn off.

TEMPERATURE LOCK FUNCTION

- This function prevents accidental changes to the temperature while the iron is being used. Activate the function by holding down button **A1** for longer than 3 seconds. A lock symbol will appear on the display and the set temperature will be locked, i.e. button **A1** will not react when pressed.
- Deactivate the function by holding down button **A1** for longer than 3 seconds. The lock symbol will turn off.



Note:

If "888" appears on the display, this indicates that there is a malfunction of the heat sensor or iron. If this happens, disconnect the iron from the power grid and contact a service centre.

AUTOMATIC SHUT-OFF FUNCTION

- If no action is taken after turning on the iron, i.e. no button is pressed, then for safety reasons, the iron will turn off automatically after 60 minutes of inactivity. It will start again after button **A1** is pressed.



Attention:

The automatic shut-off is intended only for cases, where you forget to turn off the iron using button **A1**. Do not use the automatic shut-off to intentionally turn off the iron.



TEMPERATURE DEPENDING ON HAIR TYPE

- The suitable temperature for straightening hair depends on the hair structure. Depending on the type of hair, an incorrectly selected temperature may cause the hair to dry out, become brittle or in the worst case to burn. Therefore, first try ironing at a low temperature and set a higher temperature only when necessary.

- The information contained in the following table is for reference purposes only. It may differ depending on hair type.

Hair type	Temperature
Fine, damaged, discoloured, highlighted or dyed hair	140 °C to 160 °C
Normal, lightly wavy hair	160 °C to 180 °C
Very heavy, curly, unyielding hair	180 °C to 200 °C

REMOVING AND INSERTING THE PLATES

- Slide the lock button **A8** towards symbol  (unlocked) and hold it in this position.
- Slide the cover **A7** out of the arm and release the lock button. The button will automatically slide to symbol  (locked).
- Take out the initial plate and slide a new plate on to the heating surface **A6**.
- Slide the cover **A7** back on to the arm. Correct attachment is accompanied by a click.
- Repeat the procedure also on the second arm of the iron. **ATTENTION** – Only insert the same plate types into the arms.

PROCEDURE FOR STYLING HAIR

- Wash your hair thoroughly, dry it completely and brush through thoroughly so that it is smooth and without knots.
- Separate this prepared hair using clips into equally wide strands (about 5 cm wide).
- Start to iron the back part of the head at the lower strands of hair – at the root place the strand of hair between the plates and gently press the handle of the iron. With a sliding motion pull the iron all the way to the ends of the hair.
- Repeat the procedure for the same strand of hair until you achieve the desired appearance.
- Continue in the same way with the remaining strands of hair (first on the front part of the head and ending at the sides).
- Before the final combing, allow the hair to fully cool down.



Attention:

Do not touch the ironing plates or the attachments - there is a danger of burns!
Do not leave the iron in the one spot for longer than 5 seconds as hair could be burnt.
Use the iron only on healthy hair. Do not use the iron on oily, stuck together or sweaty hair. On perm or coloured hair only use the iron infrequently.



Tip:

Adjust the speed of movement of the iron on the hair strands according to their character (fine hair is more sensitive to a hot surface and requires a significantly shorter ironing time than stronger hair).

TURNING OFF THE IRON

- When you have finished ironing, turn off the iron by pressing button **A1** until the display turns off. Turning off is also indicated by a beep.
- Disconnect the iron from the power socket.



Attention:

Allow the iron and the plates to fully cool down before storing!

CLEANING AND MAINTENANCE



Attention:

Clean the ironing plates and styling plates only after they have fully cooled down!
No part of the iron may be submerged in water or washed under running water!

- To clean the outside parts of the iron and the ironing plates, use a fine cloth dipped in lukewarm water. Do not use aggressive cleaning agents, paint thinners or solvents. Using these solutions could damage the surface of the product. The surface of the iron plates does not need any further cleaning. Prior to storing or using them again, allow them to dry completely or wipe them dry.

STORAGE

When not using the iron for an extended period of time, do the following:

- Clean the iron as described in chapter Cleaning and maintenance.
- Place the iron in a safe, dust-free, clean and dry place that is out of reach of children.
- If you wish to secure the arms against opening, press button **A2**.

TECHNICAL SPECIFICATIONS

Rated voltage range	100–240 V AC
Rated frequency.....	50/60 Hz
Rated power.....	45–50 W
Temperature range	140 to 200 °C
Electrical shock protection class.....	II

EXPLANATION OF TECHNICAL TERMINOLOGY



Safety class for electrical shock protection:

Class II – Electrical shock protection is provided by double or heavy-duty insulation.

We reserve the right to change text and technical specifications.

INSTRUCTIONS AND INFORMATION REGARDING THE DISPOSAL OF USED PACKAGING MATERIALS

Dispose of used packaging material at a site designated for waste in your municipality.

DISPOSAL OF USED ELECTRICAL AND ELECTRONIC EQUIPMENT



This symbol on products or original documents means that used electric or electronic products must not be added to ordinary municipal waste. For proper disposal, renewal and recycling hand over these appliances to determined collection points. Alternatively, in some European Union states or other European countries you may return your appliances to the local retailer when buying an equivalent new appliance.



Correct disposal of this product helps save valuable natural resources and prevents potential negative effects on the environment and human health, which could result from improper waste disposal. Ask your local authorities or collection facility for more details.

In accordance with national regulations penalties may be imposed for the incorrect disposal of this type of waste.

For business entities in European Union states

If you want to dispose of electric or electronic appliances, ask your retailer or supplier for the necessary information.

Disposal in other countries outside the European Union.

This symbol is valid in the European Union. If you wish to dispose of this product, request the necessary information about the correct disposal method from the local council or from your retailer.



This product meets all the basic requirements of EU directives related to it.